	TI3200en	<b>Technical Information</b>	
PDE1- Serie (dP)	<b>Air Differential Pressure Sensor with Active Output</b>		

The PDE1- Series (dP) is designed to measure differential pressure and temperature in HVAC systems

The sensor can be use in non aggressive, non flammable environments

Field selected measuring ranges

Optional LCD display available

The sensor works with low power supply

The control outputs are 0...10V and 4...20mA



<b>Use</b>	Compatible to all common HVAC DDC and Analog Controls systems, with/without BAS
	Differential pressure measurement in HVAC systems
	Monitoring the air dampers in the primary or secondary controls systems
	Supervision of the status of heating / cooling coils, preventing overheating / freezing
	Monitoring of fan belts
	Used in all common HVAC applications

<b>Features</b>	Sensor with active output
	Internal selectable measuring range and control output signal
	Optional LCD display
	Professional and practical product design, withstands rough environmental conditions
	Easy to use, install and maintain

<b>Product Range</b>	Order Code	Power Supply	Sensor Outputs	Response Time	Measuring Ranges	Display	Burst Pressure	Protection
	PDE1.OA	AC/DC 24V	0...10V and 4...20mA	8 seconds* / 0.8 seconds	±25Pa ±50Pa ±100Pa ±150Pa 0...25Pa 0...50Pa 0...100Pa 0...250Pa*	n/a	30kPa	IP54
	PDE1.PA					LCD		
	PDE1.EA					n/a		
	PDE1.GA					LCD		
	PDE1.FA					n/a		
	PDE1.HA					LCD		

\*default settings

<b>Sensor Specification</b>	Sensor Specification	Measured	Differential Pressure	
		Sensor Characteristics	Active	
		Response Time	8 sec or 0.8 sec	
		Sensor Outputs (3-wire)	0..10V (min 1k Ω) or 4...20mA (min. 0.5kΩ)	
		Accuracy (dP ≤2500Pa)	<125Pa ; 1% ±2Pa	
			>125Pa ; 1% ±1Pa	
		Accuracy (dP ≥2500Pa)	<125Pa ; 1.5% ±2Pa	
			>125Pa ; 1.5% ±1Pa	
Measuring Range (dP)	see 1st page			
<b>Technical Information</b>	Electrical Information	Power Supply	AC/DC 24V (±10%)	
		Frequency	50 / 60 Hz at AC 24V	
		Terminal Clamp	Screw terminal, max. 1.5mm <sup>2</sup>	
		Power Consumption	max. <1.2W	
	Mechanical Information	Cable Entry	M16, Ø6...Ø8mm cables	
		Sensing Element Position	external, top of the immersion rod	
		Range Selection	Jumper switches inside the housing	
		Connection Nozzle	Ø5mmx6.3mm	
	User Interface	Display	LCD- backlit (45.7x12.7mm)	
		Display Values	PA, kPa, inchWC, psi,	
		Zeroing Button	Press button	
		Zeroing LED	Red LED	
		Pressure Range Selection	Removable Jumpers	
	Color and Materials	Housing Cover	PC, grey	
		Housing Bottom	ABS, grey	
		Connection Nozzle	Grey ABS	
		Lock	Snap Connector	
		Cable Gland	Grey ABS	
		Gland Rubber Seal	Black Rubber	
	Environmental Conditions	Operation Temperature	0°C...+50°C	
		Operation Humidity	<95% r.h., no condensation	
		Transport Temperature	-35°C...+70°C	
		Transport Humidity	< 95% r.h.	
		Storage Temperature	-10°C...+70°C	
		Storage Humidity	< 85% r.h., no condensation	
		Norms and Directives	IP- Rating	IP54 to IEC60529
			Safety Class	III to EN 60 730
			Product Standard 1	Automatic Electric. Controls for household and similar use
	Product Standard 2		2009/EN 60 730-1	
	CE Conformities to		2004/108/EG Electromagnetic Compatibility EMV	
	LVD Directive		2014/35/EU	
	RoHS Compatibility		RoHS 2011/65/EU	
	WEEE Directive		2012/19/EU	
	Operation Climatic Condition		IEC 60 721-3-3	
Operation Mechanical Condition	IEC 60 721-3-2 to class2M2			
Transport to Climatic Condition	IEC 60 721-3-2			
Transport Mechanical Condition	IEC 60 721-3-2 to class2M2			
Storage Climatic Condition	IEC 60 721-3-1			
Storage Mechanical Condition	IEC 60 721-3-1 to class2M2			
<b>Miscellanies</b>	Accessories	Mounting Kit, Included in delivery	PUK0.A	
	Shipping & Handling	Minimum Order	1 box with 1 piece	
		Package Material	Rigid Cardboards	
	Order Notes	Order Code	See Product Range, Page 1, e.g. PDE1.EA	

All Information and technical data are subject to alteration

## SCHEMATICS

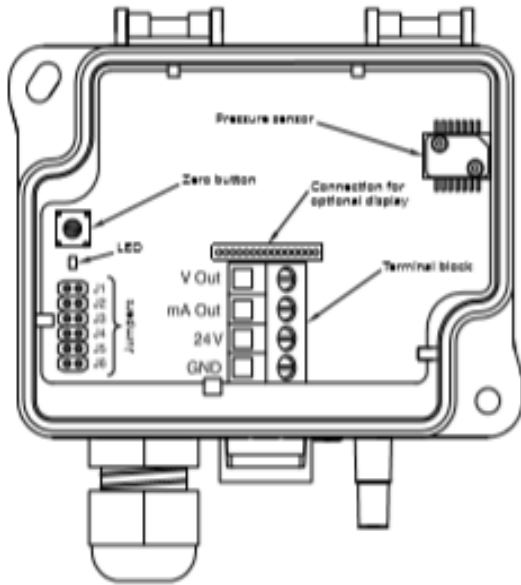

## DIMENSIONAL DRAWINGS

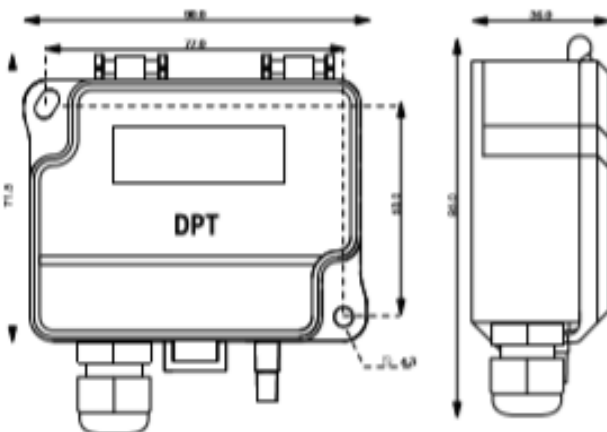

## INSTALLATION

- 1) Mount the device in the desired location (see step 1).
- 2) Open the lid and route the cable through the strain relief and connect the wires to the terminal block(s) (see step 2).
- 3) The device is now ready for configuration.

**⚠ WARNING!** Apply power only after the device is properly wired.

## STEP 1: MOUNTING THE DEVICE

- 1) Select the mounting location (duct, wall, panel).
- 2) Use the device as a template and mark the screw holes.
- 3) Mount with appropriate screws.

Figure 1a - Mounting orientation

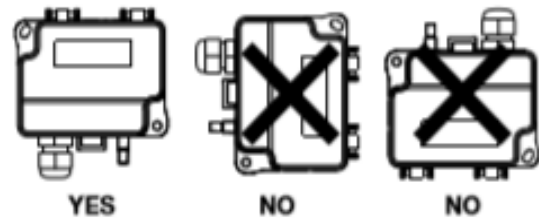
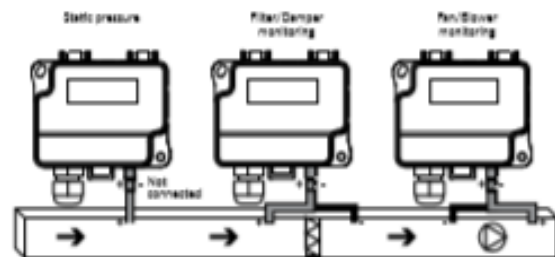

Figure 1b - Application connections



## STEP 2: WIRING DIAGRAMS

For CE compliance, a properly grounded shielding cable is required.

- 1) Unscrew the strain relief and route the cable(s).
- 2) Connect the wires as shown in figure 2a and 2b.
- 3) Tighten the strain relief.

Figure 2a - Wiring diagram 0-10 V output

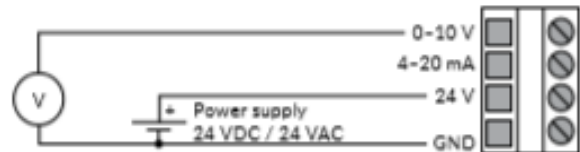
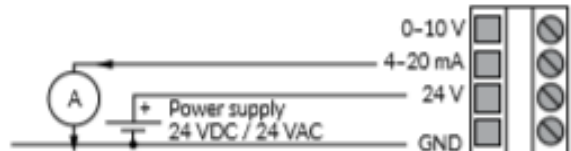

Figure 2b - Wiring diagram 4-20 mA output



### STEP 3: CONFIGURATION

- 1) Select the desired measurement unit. (see step 4)
- 2) Select the desired measurement range. (see step 5)
- 3) Select the desired response time. (see step 6)
- 4) Zero the device. (see step 7)
- 5) Connect the pressure tubes. Connect positive pressure to port labeled "+" and negative pressure to port "-".
- 6) Close the lid. The device is now ready to be used.

### STEP 4: SELECTING THE MEASUREMENT UNIT

- 1) To change the measurement unit appearing on the display, install a jumper to both pins of J5 (see Figure 3).
- 2) Push down the zero button and the measurement unit options (Pa, kPa, mbar, inchWC, mmWC, psi) will cycle on the display.
- 3) To select a unit option to display, remove the jumper from J5 while the measurement unit is visible on the display.

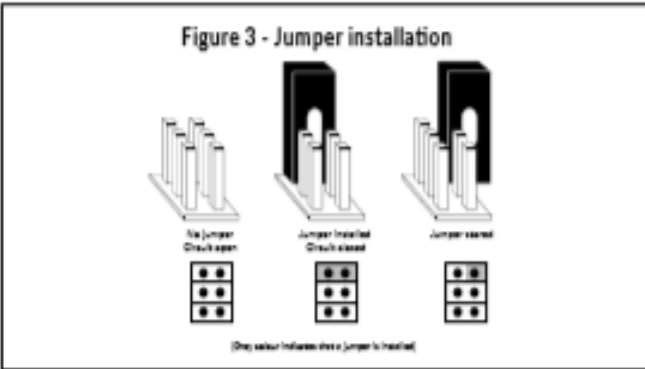

### STEP 5: SELECTING THE MEASUREMENT RANGE

- 1) Determine the range number
  - a. Find the model in Chart 1.
  - b. Find the measurement unit (selected in step 4).
  - c. Find the required measurement range on the same line as the measurement unit (b above) and determine the range number in the header.

### SELECTING THE MEASUREMENT RANGE CONTINUED

- 2) Install jumpers on J1, J2 and J3 as required.
  - a. Using the range number from 1c above, find the corresponding range number in Chart 2.
  - b. Install jumpers on J1, J2 and J3 on device, as shown under the range number in Chart 2. (Grey colour indicates that a jumper is installed. Reference figure 3 for jumper installation.)

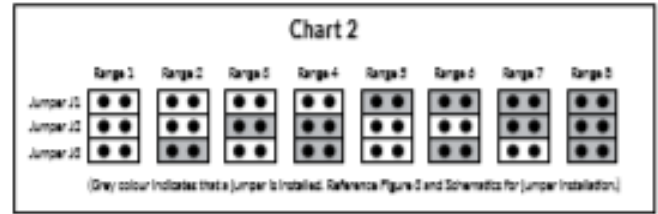

### STEP 6: SELECTING THE RESPONSE TIME

The response time affects how fast the transmitter reacts to changes in the system. The response time is the time the device takes to reach 63 % of the measured value. To smooth out unstable pressure fluctuations in airflow applications, select a longer response time.

Example:

Selected response time: 8.0 seconds

Result: Output signal achieves a new value in 20 seconds (Response time\*5)

To change response time, install or remove jumper on J4. (see Figure 3)

- 1) Install jumper on J4 for 8.0 second response time.
- 2) Remove jumper from J4 for 0.8 second response time.

Chart 1

#### Model DPT250-R8

	Range 1	Range 2	Range 3	Range 4	Range 5	Range 6	Range 7	Range 8
Pa	0-25	0-50	0-100	0-250	-25-25	-50-50	-100-100	-150-150
kPa	0-0.025	0-0.05	0-0.1	0-0.25	-0.025-0.025	-0.05-0.05	-0.1-0.1	-0.15-0.15
mbar	0-0.25	0-0.50	0-1.00	0-2.50	-0.25-0.25	-0.50-0.50	-1.0-1.00	-1.50-1.50
InchWC	0-0.10	0-0.20	0-0.40	0-1.00	-0.10-0.10	-0.20-0.20	-0.40-0.40	-0.60-0.60
mmWC	0-2.5	0-5.1	0-10.2	0-25.5	-2.5-2.5	-5.1-5.1	-10.2-10.2	-15.0-15.0
psi	0-0.0056	0-0.0078	0-0.0145	0-0.0366	-0.0056-0.0056	-0.0078-0.0078	-0.0145-0.0145	-0.0208-0.0208

#### Model DPT2500-R8

	Range 1	Range 2	Range 3	Range 4	Range 5	Range 6	Range 7	Range 8
Pa	-100-100	0-100	0-250	0-500	0-1000	0-1500	0-2000	0-2500
kPa	-1.0-1.0	0-1.0	0-2.5	0-5.0	0-10.0	0-15.0	0-20.0	0-25.0
mbar	-1.00-1.00	0-1.00	0-2.50	0-5.00	0-10.0	0-15.0	0-20.0	0-25.0
InchWC	-0.40-0.40	0-0.40	0-1.00	0-2.00	0-4.00	0-6.00	0-8.00	0-10.00
mmWC	-10.2-10.2	0-10.2	0-25.5	0-51.0	0-102.0	0-153.0	0-204.0	0-255.0
psi	-0.0145-0.0145	0-0.0145	0-0.0366	0-0.0732	0-0.1464	0-0.2173	0-0.2900	0-0.3628

#### Model DPT7000-R8

	Range 1	Range 2	Range 3	Range 4	Range 5	Range 6	Range 7	Range 8
Pa	0-1000	0-1500	0-2000	0-2500	0-3000	0-4000	0-5000	0-7000
kPa	0-1.00	0-1.50	0-2.0	0-2.50	0-3.00	0-4.00	0-5.00	0-7.00
mbar	0-10.0	0-15.0	0-20.0	0-25.0	0-30.0	0-40.0	0-50.0	0-70.0
InchWC	0-4.00	0-6.00	0-8.00	0-10.0	0-12.00	0-16.00	0-20.00	0-28.00
mmWC	0-102.0	0-153.0	0-204.0	0-255.0	0-306.0	0-408.0	0-510.0	0-714.0
psi	0-0.1450	0-0.2173	0-0.2900	0-0.3628	0-0.4356	0-0.5800	0-0.7300	0-1.0100

## STEP 7: ZEROING THE DEVICE

**NOTE!** Always zero the device before use.

To zero the device two options are available:

- 1) Manual Pushbutton zero point calibration
- 2) Autozero calibration

Does my transmitter have an autozero calibration? See the product label. If it shows -AZ in the model number, then you have the autozero calibration.

- 1) Manual Pushbutton zero point calibration

**NOTE:** Supply voltage must be connected at least one hour prior to zero point adjustment.

- a) Disconnect both pressure tubes from the pressure ports labeled + and -.
- b) Push down the zero button until the LED light (red) turns on and the display reads "zeroing" (display option only). (see Figure 4)
- c) The zeroing of the device will proceed automatically. Zeroing is complete when the LED turns off, and the display reads 0 (display option only).
- d) Reinstall the pressure tubes ensuring that the High pressure tube is connected to the port labeled +, and the Low pressure tube is connected to the port labeled -.

Figure 4

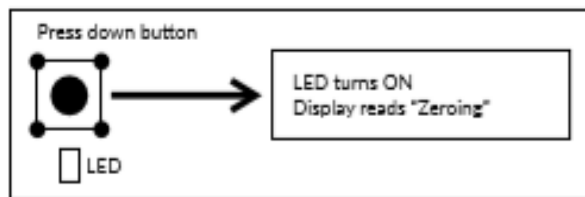

- 2) Autozero calibration

If the device includes the optional autozero circuit, no action is required.

Autozero calibration (-AZ) is an autozero function in the form of an automatic zeroing circuit built into the PCB board. The autozero calibration electronically adjusts the transmitter zero at predetermined time intervals (every 10 minutes). The function eliminates all output signal drift due to thermal, electronic or mechanical effects, as well as the need for technicians to remove high and low pressure tubes when performing initial or periodic transmitter zero point calibration. The autozero adjustment takes 4 seconds after which the device returns to its normal measuring mode. During the 4 second adjustment period, the output and display values will freeze to the latest measured value.

Transmitters equipped with the autozero calibration are virtually maintenance free.

## -40C MODEL: OPERATION IN COLD ENVIRONMENT

The lid of the device has to be closed when the operation temperature is below 0 °C. The display needs 15 minutes to warm up if the device is started in temperature below 0 °C.

**NOTE!** The power consumption rises and there can be an additional error of 0,015 V or 0,024 mA when the operation temperature is below 0 °C.

## RECYCLING/DISPOSAL

The parts left over from installation should be recycled according to your local instructions. Decommissioned devices should be taken to a recycling site that specializes in electronic waste.



## WARRANTY POLICY

The seller is obligated to provide a warranty of five years for the delivered goods regarding material and manufacturing. The warranty period is considered to start on the delivery date of the product. If a defect in raw materials or a production flaw is found, the seller is obligated, when the product is sent to the seller without delay or before expiration of the warranty, to amend the mistake at his/her discretion either by repairing the defective product or by delivering free of charge to the buyer a new flawless product and sending it to the buyer. Delivery costs for the repair under warranty will be paid by the buyer and the return costs by the seller. The warranty does not comprise damages caused by accident, lightning, flood or other natural phenomenon, normal wear and tear, improper or careless handling, abnormal use, overloading, improper storage, incorrect care or reconstruction, or changes and installation work not done by the seller or his/her authorized representative. The selection of materials for devices prone to corrosion is the buyer's responsibility, unless otherwise is legally agreed upon. Should the manufacturer alter the structure of the device, the seller is not obligated to make comparable changes to devices already purchased. Appealing for warranty requires that the buyer has correctly fulfilled his/her duties arisen from the delivery and stated in the contract. The seller will give a new warranty for goods that have been replaced or repaired within the warranty, however only to the expiration of the original product's warranty time. The warranty includes the repair of a defective part or device, or if needed, a new part or device, but not installation or exchange costs. Under no circumstance is the seller liable for damages compensation for indirect damage.